

Set 2

Phonics at

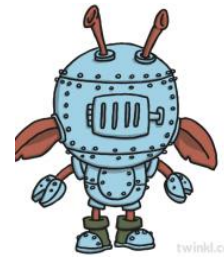

Home



Revision



Guide



This phonics booklet has been designed to be completed as a revision guide at the end of set 2 sounds (ay, ee, igh, ow, oo, oo).

Children should be able to complete this booklet independently, following a little explanation of each activity.

Remember you can add sound buttons, like we do in class, to help you to read the words.

Thank you for your continued support ☺

Read Write Inc Phonics





SET 1		SET 2	
Sound	Rhyme	Sound	Rhyme
m	Down Maisie then over the two mountains, Maisie, mountain, mountain.	ay	May I Play?
a	Round the apple, down the leaf.	ee	What can you see?
s	Slide around the snake	igh	Fly high
d	Round the dinosaur's back, up his neck and down to his feet.	ow	Blow the snow
t	Down the tower, across the tower.	oo	Poo at the zoo
i	Down the insects body, dot for the head.	oo	Look at a book
n	Down Nobby and over the net.	ar	Start the car
p	Down the plait, up and over the pirates face.	or	Shut the door
g	Round the girls face, down her hair and give her a curl.	air	That's not fair
o	All around the orange.	ir	Whirl and twirl
c	Curl around the caterpillar.	ou	Shout it out
k	Down the kangaroo's body, tail and leg.	oy	Toy for a boy
u	Down and under the umbrella, up to the top and down to the puddle.		
b	Down the laces, over the toe and touch the heel.		
f	Down the stem and draw the leaves.		
e	Slice into the egg, go over the top, then under the egg.	<p>Start everyday by recapping all of these sounds. Point and read the sounds not the rhymes.</p>	
l	Down the long leg.		
h	Down the horse's head to the hooves and over his back.		
sh	Slither down the snake, then down the horse's head to the hooves and over his back.		
r	Down the robot's back, then up and curl.		
j	Down his body, curl and dot.		
v	Down a wing, up a wing.		
y	Down a horn, up a horn and under the yak's head.		
w	Down, up, down, up the worm.		
th	Down the tower, across the tower, then down the horse's head to the hooves and over his back		
z	Zig-zag-zig, down the zip.		
ch	Curl around the caterpillar, then down the horse's head to the hooves and over his back.		
qu	Round the queen's head, up to her crown, down her hair and curl.		
x	Cross down the arm and leg and cross the other way.		
ng	A thing on a string.		
nk	I think I stink.		

Take the time to introduce this sound to your child. Tell them the sound and encourage them to colour in the sound as they read the words.

Real Words



Alien Words

<small>Get 2 Hocuswinkie Words: ay</small>  tay	<small>Get 2 Hocuswinkie Words: ay</small>  shay
<small>Get 2 Hocuswinkie Words: ay</small>  kay	<small>Get 2 Hocuswinkie Words: ay</small>  dray
<small>Get 2 Hocuswinkie Words: ay</small>  chay	<small>Get 2 Hocuswinkie Words: ay</small>  blay



Colour in all the ay words you can find



Dear Fay,

There was such a big delay when I went on holiday to Norway. My ticket was for Saturday but I had to wait until Sunday.

I checked the flight on the display and it said 'DELAYED' in big, red letters. I had to stay in the airport overnight, so I lay across some chairs and played with my crayons.

Sway Airways felt bad for the delay and said I did not need to pay and I got a free tray of food on the way to Norway. Hooray!

Did you have a good birthday yesterday?

Dontay



Tick the real words and cross the nonsense words.



Key

Real Words <input checked="" type="checkbox"/>	Nonsense Words <input type="checkbox"/>
--	---







clayer	spray	play	zlay
may	vray	hayon	clay
chay	stray	day	tay
crayon	blay	dayb	tray
	nayt	stay	

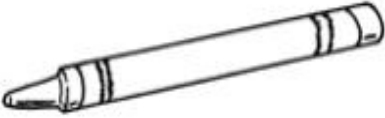

Spelling words with ay.



Write the words in the spaces. There is a line for each letter of the word.

		
_ _ _ o n	_ _ _	_ _ _
		
_ _ _	_ _ _	_ _ _

Answers- 1. crayon 2. hay 3. play 4. pray 5. spray 6. tray

Take the time to introduce this sound to your child. Tell them the sound and encourage them to colour in the sound as they read the words.

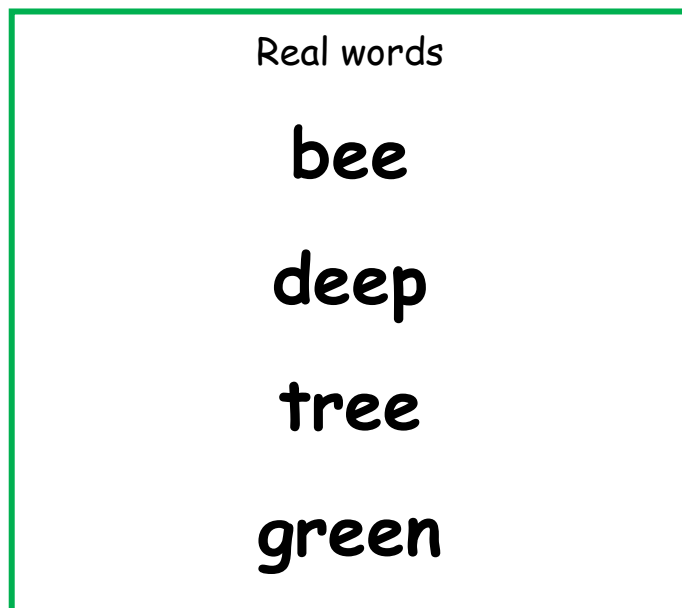
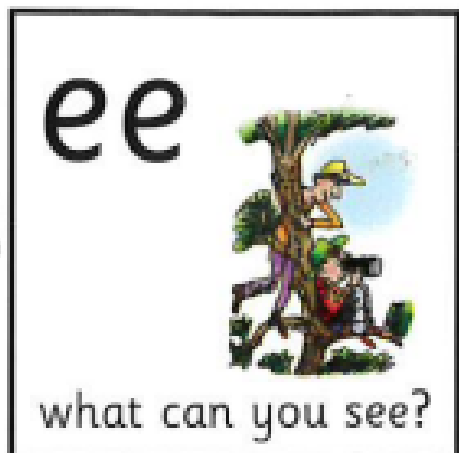

Alien words



The Bee Tree

★ Colour in all the ee words you can find. ★



In a park with lots of weeds, stands a big, green tree.



Sheep often go to sleep under the tree. The sheep need to get shelter from the hot sun.



Near to the tree, is a deep creek. The sheep's feet go in the creek to cool them down.

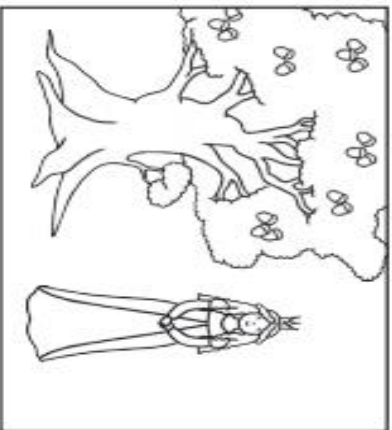

The Queen Dee went to see the tree.

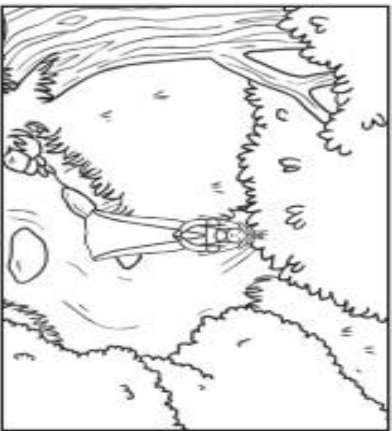

She too put her feet in the creek, as it was hot.



Then, she fell asleep under the tree.

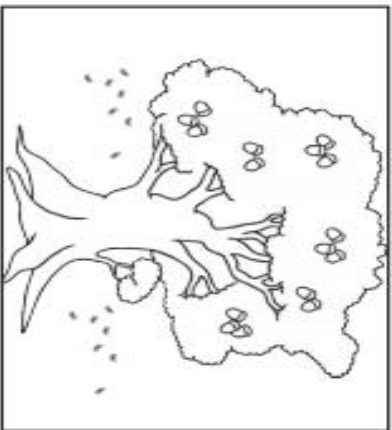

Next, a lot of bees went to the tree.



The bees stung the queen on her heel and cheek. She had a weep, as it hurt a lot. She never went back to the tree.



Tick the real words and cross the nonsense words.



Key

Real Words



Nonsense Words



bee	geep	deep	yeep
zeek	see	week	zeesh
feel	cheen	weed	meet
jeex	weep	yeech	seem
been	keep	feet	cheek



Spelling words with ee.



Write the words in the spaces. There is a line for each letter of the word.



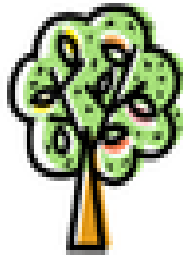





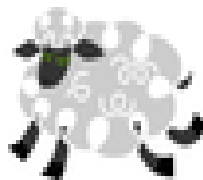

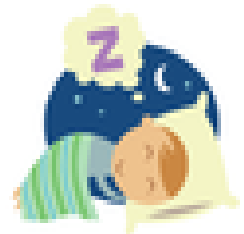

Answers- 1. bee 2. tree 3. heel 4. feet 5. sheep 6. sleep

Take the time to introduce this sound to your child. Tell them the sound and encourage them to colour in the sound as they read the words.

Real Words



high
might
fight
sight

Alien Words

<small>Get 3 Hocusaurus Words: igh</small>  quigh	<small>Get 3 Hocusaurus Words: igh</small>  zigh
<small>Get 3 Hocusaurus Words: igh</small>  kigh	<small>Get 3 Hocusaurus Words: igh</small>  glight
<small>Get 3 Hocusaurus Words: igh</small>  dight	<small>Get 3 Hocusaurus Words: igh</small>  pright

The Light in the Night



Colour in all the igh words you can find

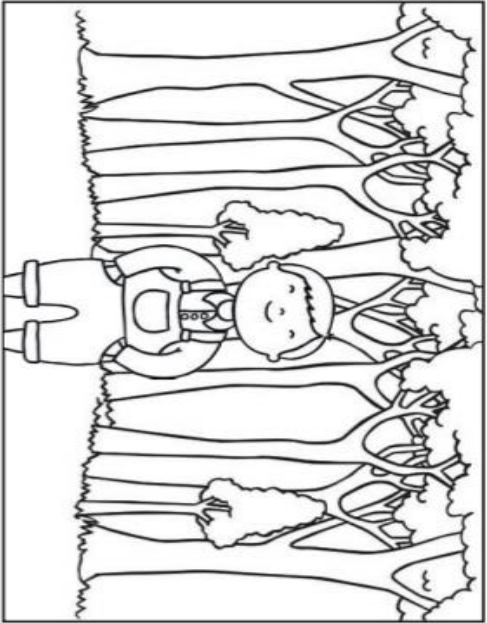

Dwight was in the woods. He often went to the woods with his mum and dad.

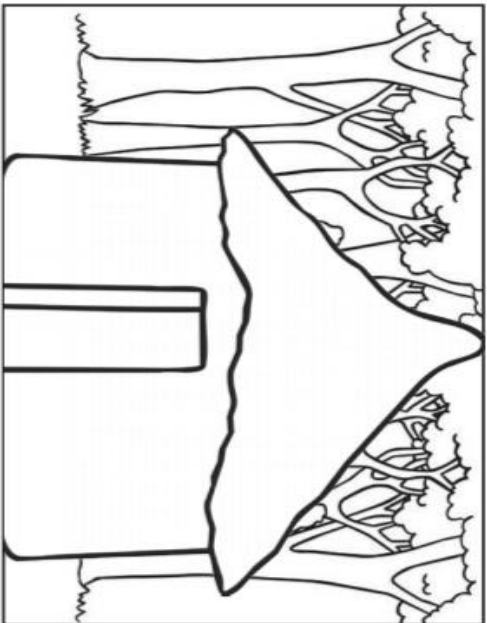

They had a hut that had beds in it. In the summer, they slept in the hut.

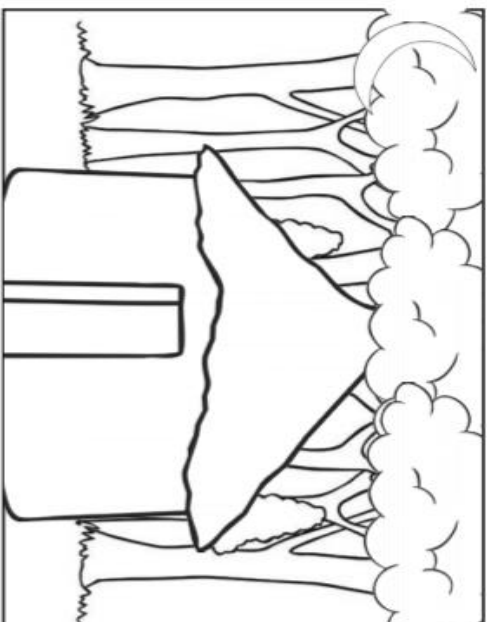

The wood was dark at night. The hut was dark too. It did not contain a light.



Dwight slept next to his mum and dad, as he often got a fright.

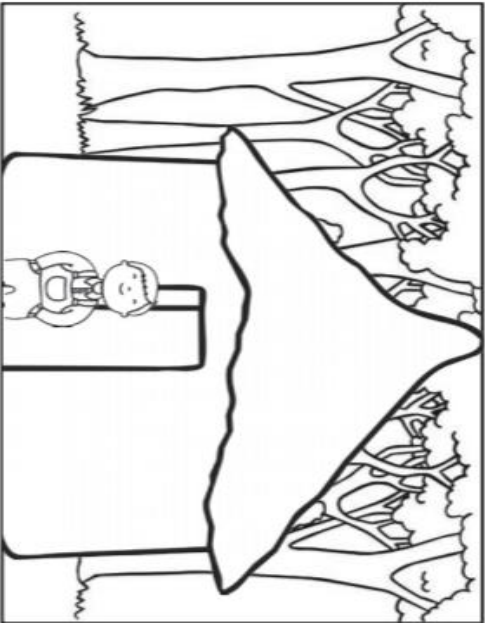

One night in winter, Dwight had to sleep in the hut, as his mum and dad went to hunt for

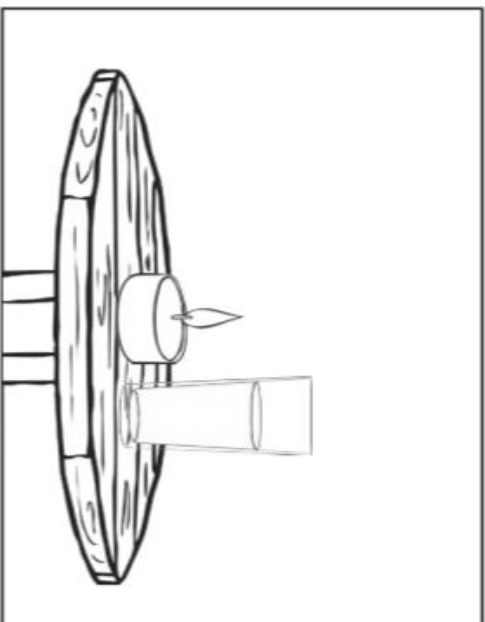

Then, he did see a bright light. His mum and dad had put it next to his bed. He did not need



Tick the real words and cross the nonsense words.



Key

Real Words



Nonsense Words



high	jight	sight	bight
pight	quigh	dight	fight
sigh	yight	right	gight
thight	chigh	night	tight
light	might	kigh	tonight



Spelling words with igh.



Write the words in the spaces. There is a line for each letter of the word.



— — — — —



— — — — —



— — — — —



kn — — —

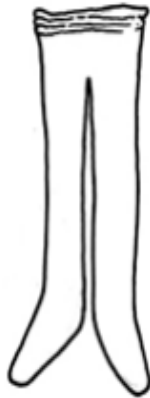

t — — — —

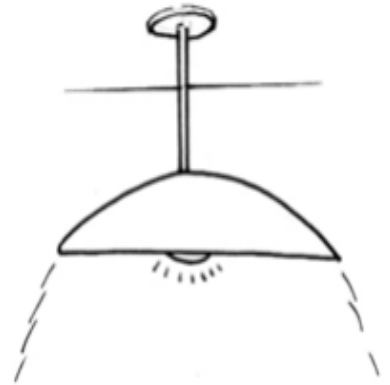

— — — — —

Answers- 1. night 2. fight 3. right 4. knight 5. tights 6. light

Take the time to introduce this sound to your child. Tell them the sound and encourage them to colour in the sound as they read the words.

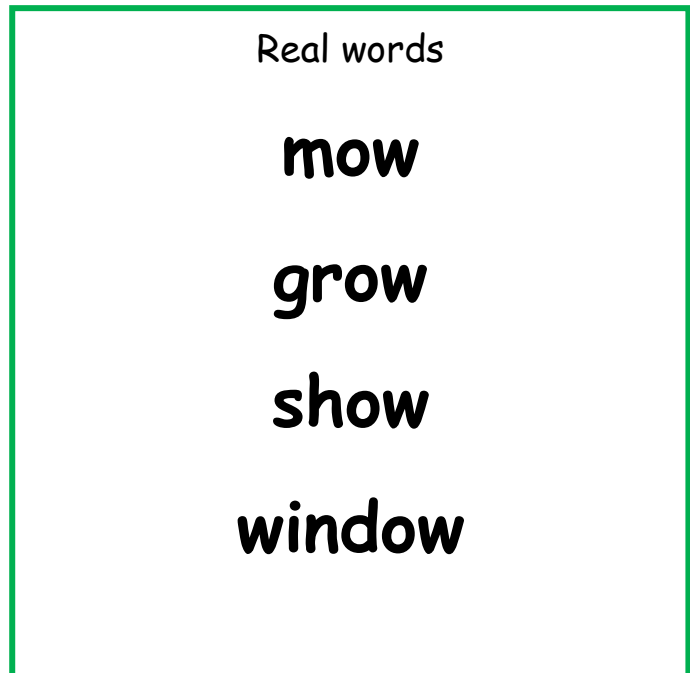
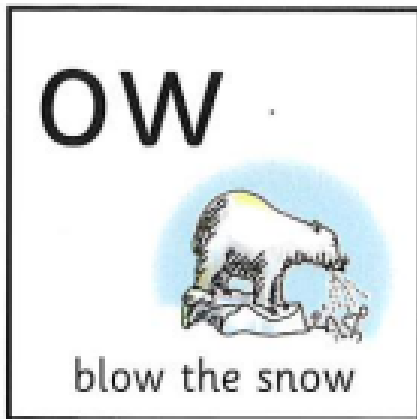

Alien words

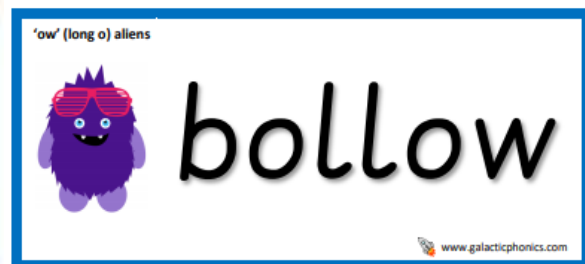

The Crow in the Snow



This crow wants to grow. This crow wants to show how high she can go.

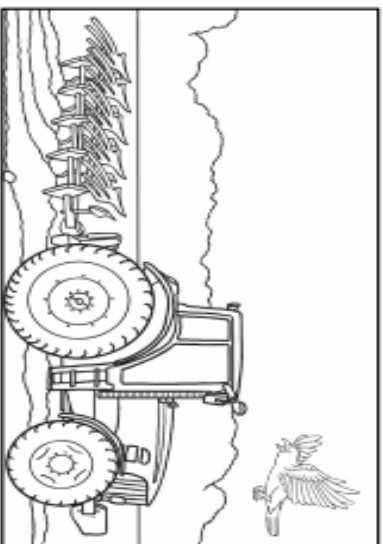

This crow flaps up high. She sees so much below! She sees the farmer mow. She sees her shadow.



Just then wind starts to blow... It starts to snow! The wind blows the snow and the crow. Oh no!



The wind and the snow blow the crow past a window. "Hello crow!" says the kid at the window.



Then the crow sees a rainbow! The snow stops and the wind starts to slow.

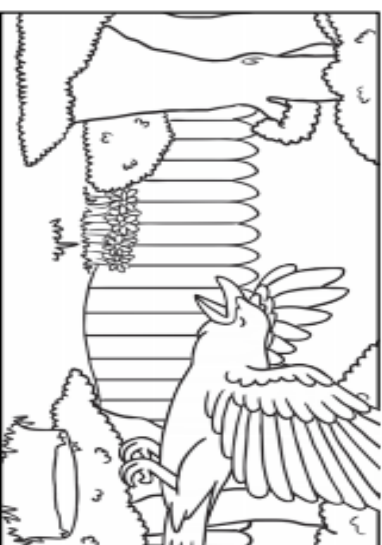

At last, the poor crow can fly low. The crow is glad she is not in the wind and the snow! But she is glad she showed how high she can go!

Colour in all the ow words you can find



Tick the real words and cross the nonsense words.



Key

Real Words



Nonsense Words



blow

prow

thow

kowg

mow

snow

chow

grow

cowr

flow

zow

vowd





towj

drow

yellow

★ Spelling words with ow ★

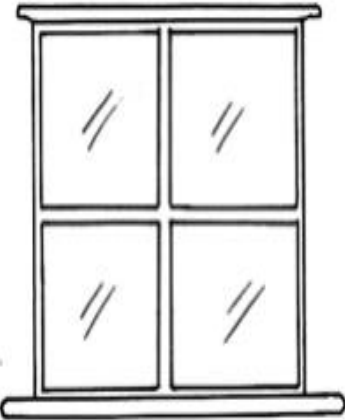
Write the words in the spaces. There is a line for each letter of the word.

		
<p>— — — — —</p>	<p>— — — — —</p>	<p>— — — — —</p>
		
<p>w i n _ _</p>	<p>_ _</p>	<p>_ _ _</p>

Answers- 1. elbow 2. arrow 3. snow 4. window 5. row 6. blow

Take the time to introduce this sound to your child. Tell them the sound and encourage them to colour in the sound as they read the words.

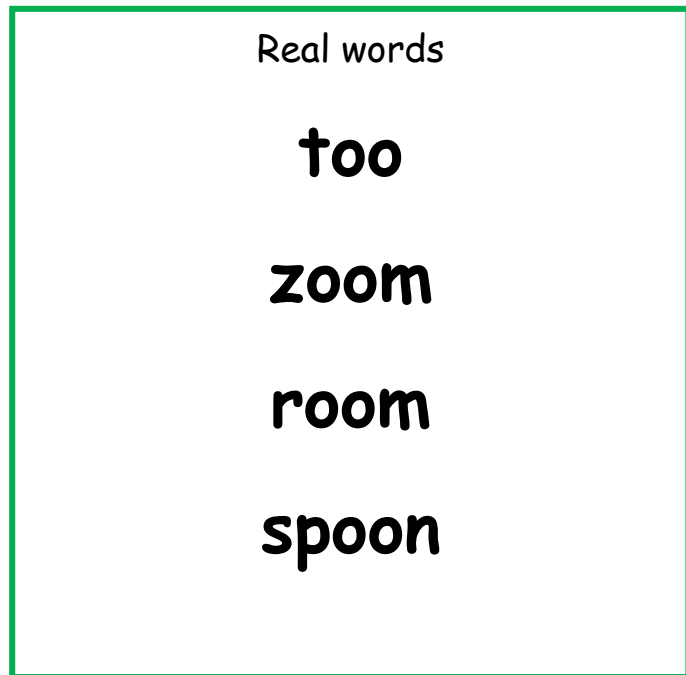
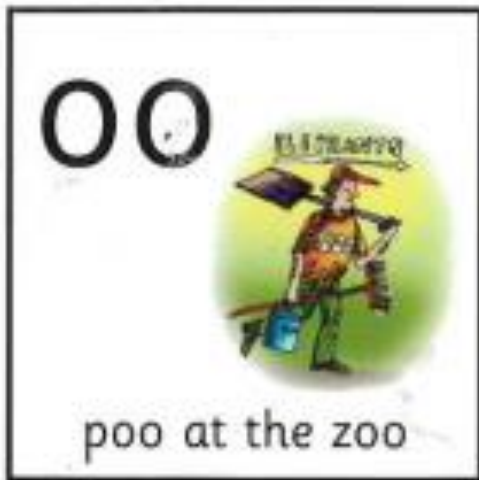

Alien words



Keeping Cool



Colour in all the oo words you can find

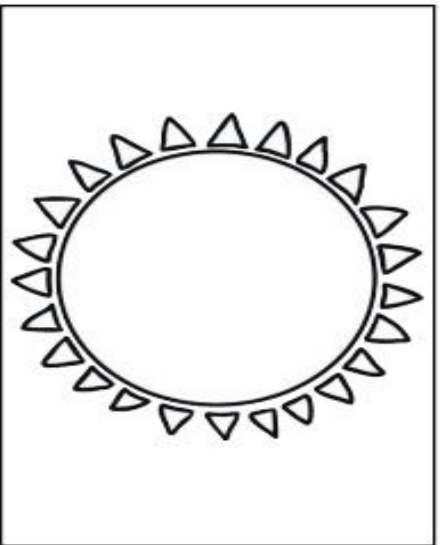

It was summer. It was getting hot.

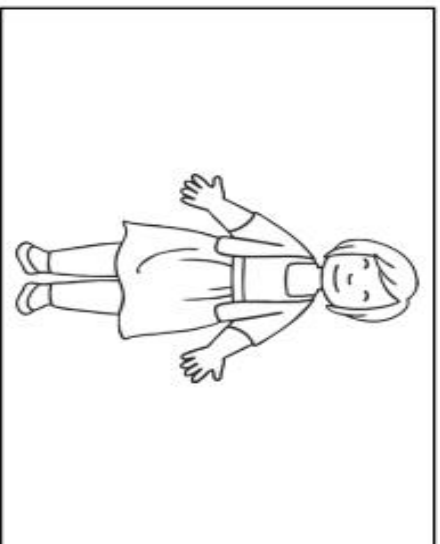

Jools had fair skin. She had to look after herself if it got too hot.



Her mum put up a list of tips in her room.

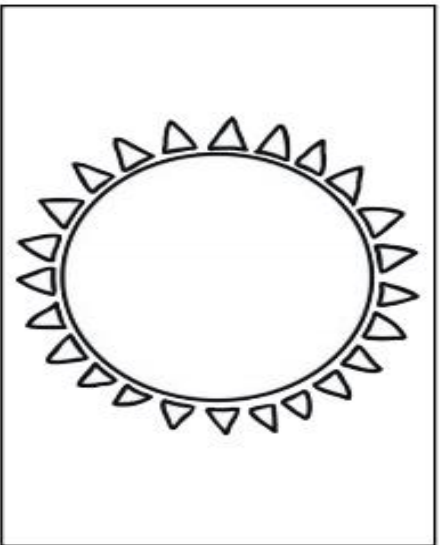

You must not go in the hot sun from 12 until 3.

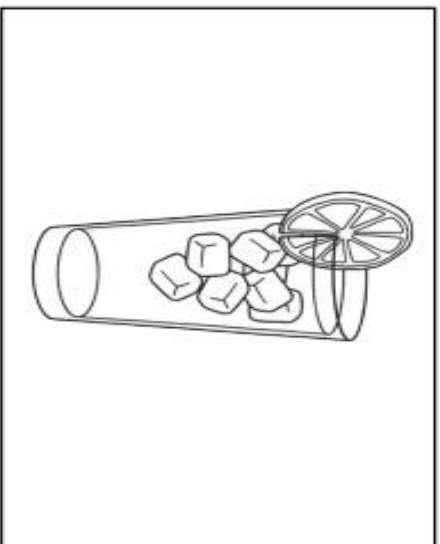

You must drink lots of cool drinks.

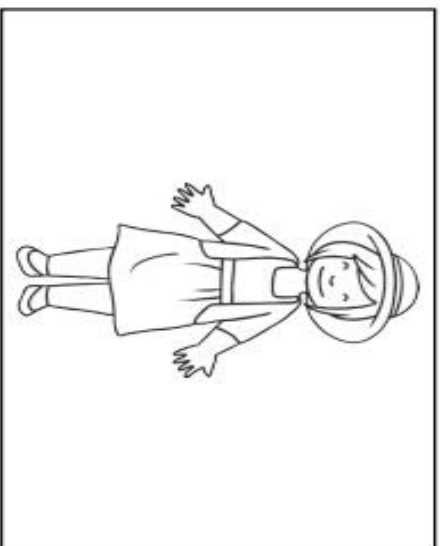

Put a hat on to keep the sun off you.



Tick all the read words and cross the nonsense words



Key

Real Words









Nonsense Words

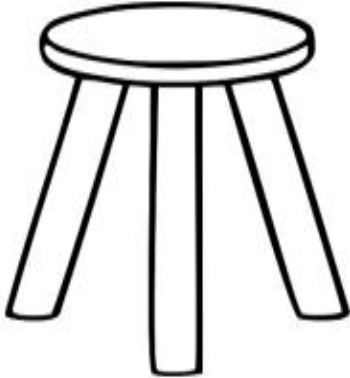

zoo	nooth	thoog	root
book	boot	cook	food
jooz	moox	toog	shoom
joof	hoof	zoom	dooth
look	hood	wood	moon

★ Spelling words with oo ★

Write the words in the spaces. There is a line for each letter of the word.

		
— — — — —	— — — — —	— — — — —
		
— — — — —	— — — — —	— — — — —

Answers- 1. stool 2. boot 3. moon 4. roof 5. spoon 6. broom

Take the time to introduce this sound to your child. Tell them the sound and encourage them to colour in the sound as they read the words.

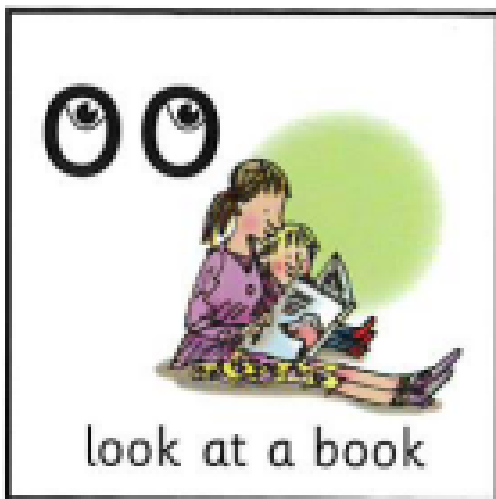

Real words

cook

wool

foot

shook

Alien words

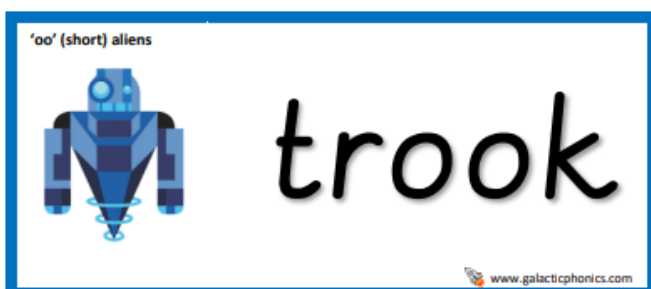
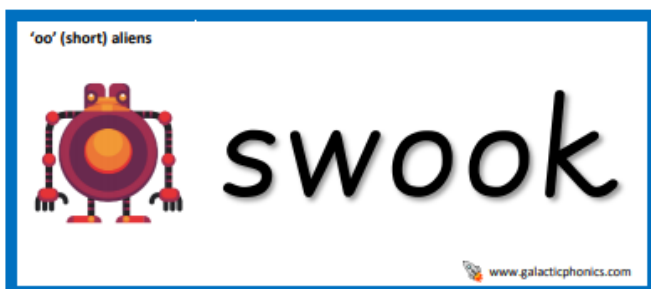

The Cook in the Wood

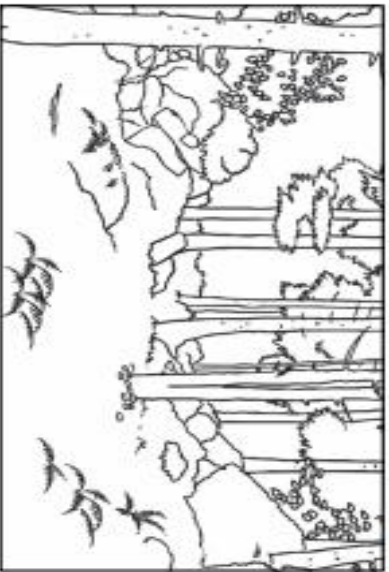

Deep in the dark woods, was a person. This person had not been seen for years.

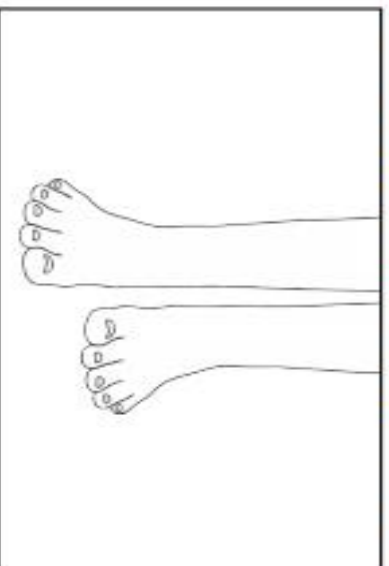

She had a good foot and a bad foot so she had to hop.

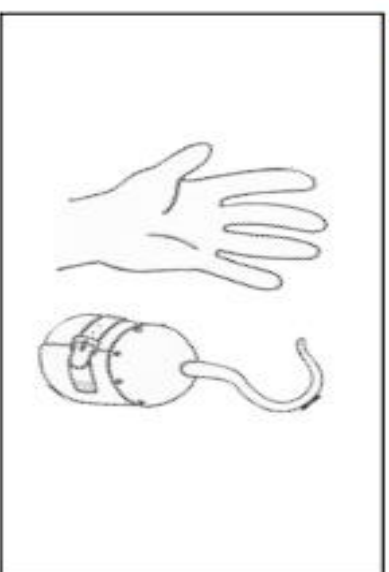

She had a good hand and a bad hand. In fact, her left hand was a hook. This hook had been on her arm for fifteen years.

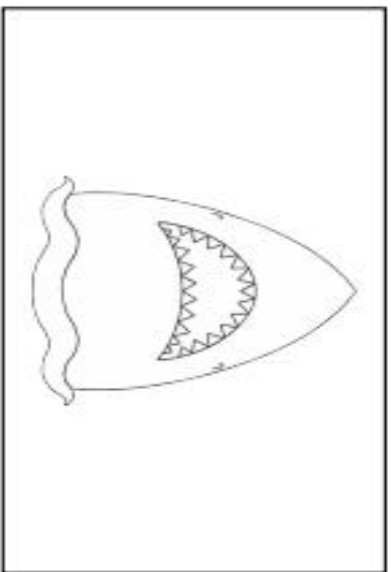

Fifteen years ago, a shark bit her hand off!

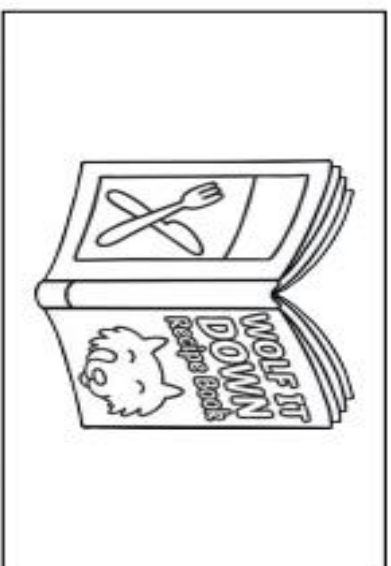

In the woods, she was sad. To cheer herself up, she was a cook. She was a good cook. She had some books too. Her best book was a cook book.

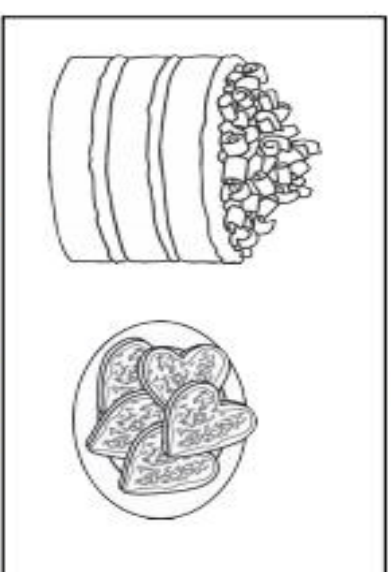

She cooked good things and sent them to shops for them to sell.

Colour in all the oo words you can find





Tick the real words and cross the nonsense words



Key

Real Words



Nonsense Words



cook

soof

look

joot

shook

poom

wook

loop

good

stood

hook

coog

foot

boov

wood

★ Spelling words with oo ★

Write the words in the spaces. There is a line for each letter of the word.

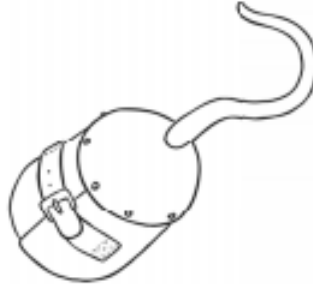
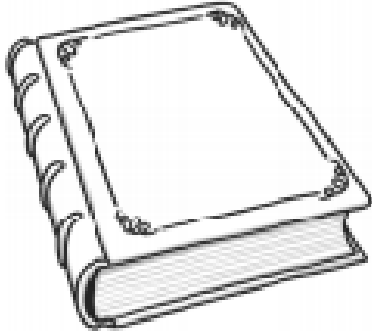

Answers- 1. book 2. hook 3. cook 4. foot 5. wood 6. hood

Take the time to introduce this sound to your child. Tell them the sound and encourage them to colour in the sound as they read the words.

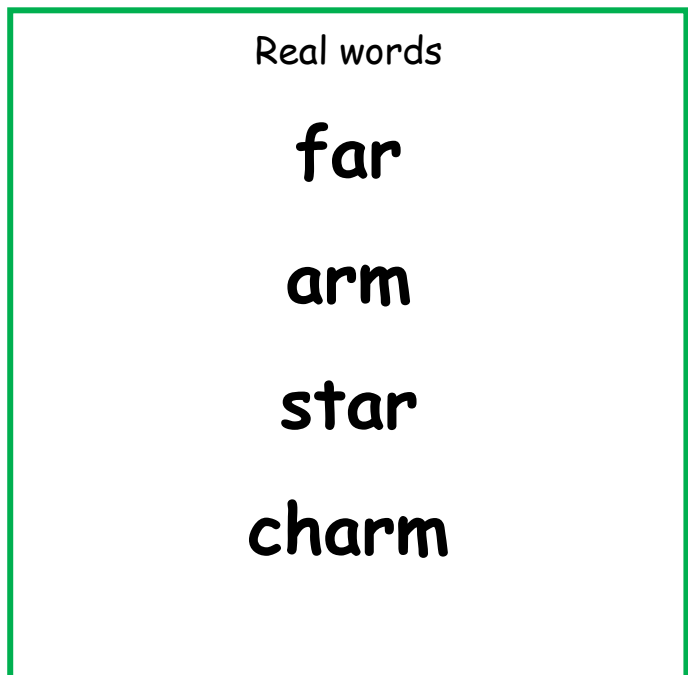
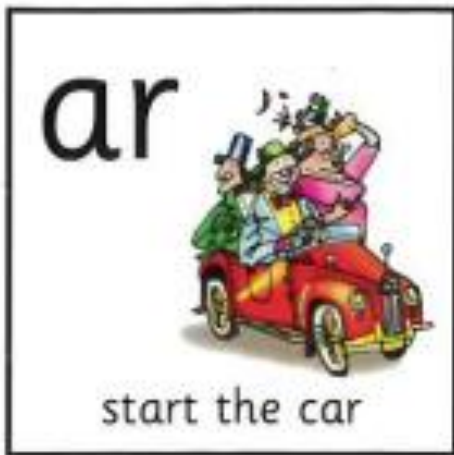

Alien words





Colour in all the ar words you can find



A Shark in the Park

Marvin and Arthur went to the park on a bright day. The park was not too far so they did not need the car.

At the park, the sun went in and it started to get a bit dark. Marvin and Arthur went to the far end of the park. In the pond, they spotted a fin. They went to the pond and there was a shark. The shark had a lot of sharp teeth and was swimming to Marvin and Arthur.

The shark swam to harm them so they left the park.





Tick all the real word and cross the nonsense words



Key

Real Words



Nonsense Words



bar	garx	hard	quarsh
car	warl	jar	quarp
bark	barsh	park	darsh
card	carsh	farm	zarsh
cart	yarp	yard	narf

★ Spelling words with ar ★

Write the words in the spaces. There is a line for each letter of the word.













Answers- 1. bar 2. star 3. car 4. jar 5. scar 6. shark

Take the time to introduce this sound to your child. Tell them the sound and encourage them to colour in the sound as they read the words.

Real Words



or



shut the door

fork
short
born
thorn

Alien Words

<small>Get 2 Phonics Words: or</small>  forg	<small>Get 2 Phonics Words: or</small>  sporg
<small>Get 2 Phonics Words: or</small>  sorm	<small>Get 2 Phonics Words: or</small>  morch
<small>Get 2 Phonics Words: or</small>  thorch	<small>Get 2 Phonics Words: or</small>  sorm

The Unicorn



Colour in all the or words you can find

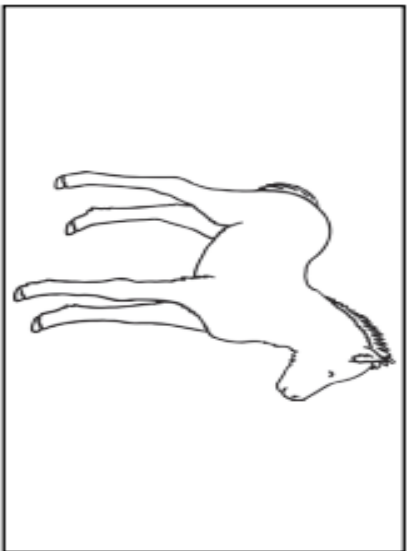

Up in the north, near to York,
was a foal.



On a wet night, in a storm, the
foal was born.



A vet went to help.



The foal was a bit different. He
was short.

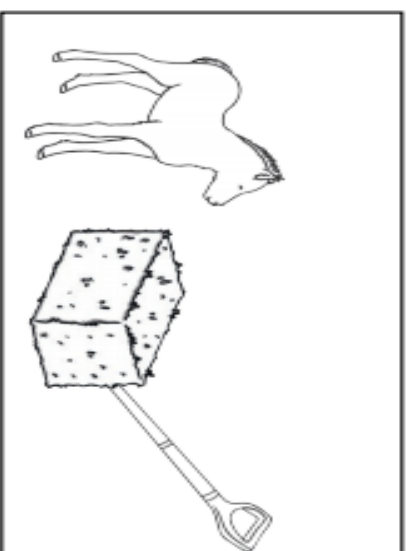

They fed him food with a fork to
help him get bigger. He did not
get bigger.



After that, the foal got a horn. He
had a big horn. In fact, he was not
a foal, he was a unicorn.



Tick all the real words and cross all the nonsense words



Real Words <input checked="" type="checkbox"/>	Nonsense Words <input type="checkbox"/>
--	---

for	quorb	fort	quorsh
morsh	fork	quorz	worn
torn	porp	cord	worsh
dorp	born	jorsh	cork
sort	zorf	corn	horsh

★ Spelling words with or ★

Write the words in the spaces. There is a line for each letter of the word.

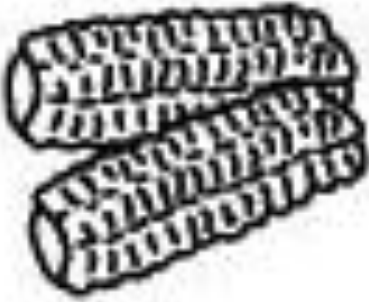



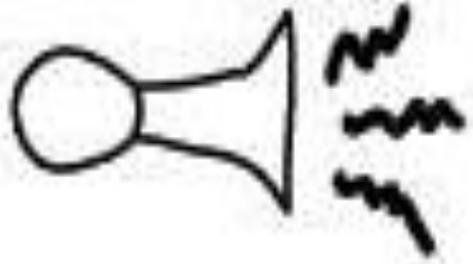







Answers- 1. corn 2. fork 3. horn 4. born 5. torch 6. doctor

Take the time to introduce this sound to your child. Tell them the sound and encourage them to colour in the sound as they read the words.

Real Words



air
fair
chair
stair

Alien Words

Get 3 Honesome Wombat: air



sair

Get 3 Honesome Wombat: air



nair

Get 3 Honesome Wombat: air



gair

Get 3 Honesome Wombat: air



yair

Get 3 Honesome Wombat: air



zair

Get 3 Honesome Wombat: air



plair

Clair at the Funfair

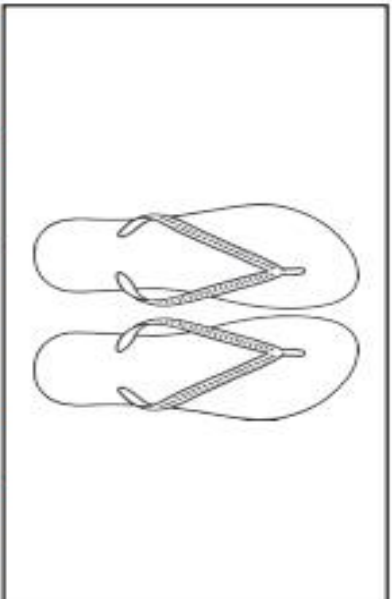

It was hot. Clair sat on a chair to put on a pair of red flip-flops.

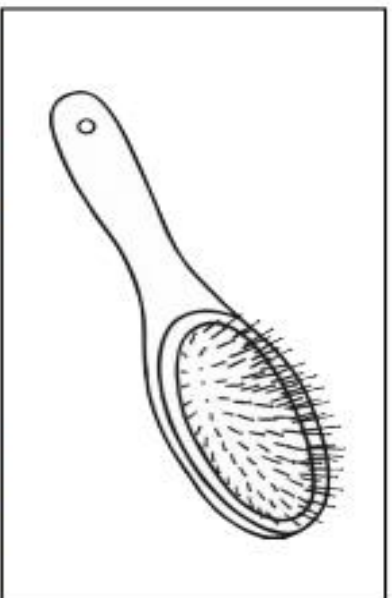

Then, she brushed her short hair and put in a clip.

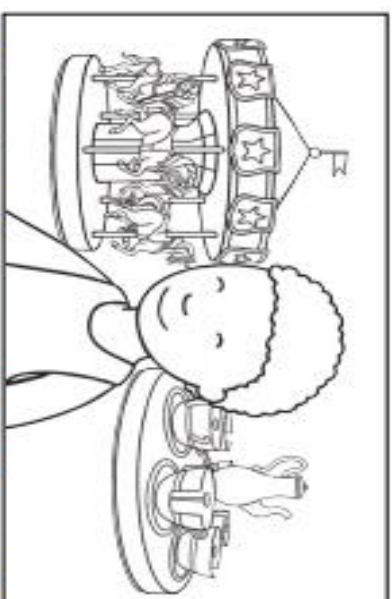

After that, she set off to the park. Clair went to the funfair at the park. The fair was fun.

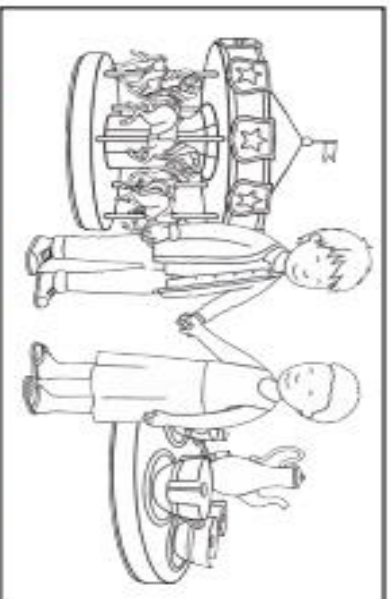

At the park, she met Gair. They went to get a ticket together. The fair ticket was silver.

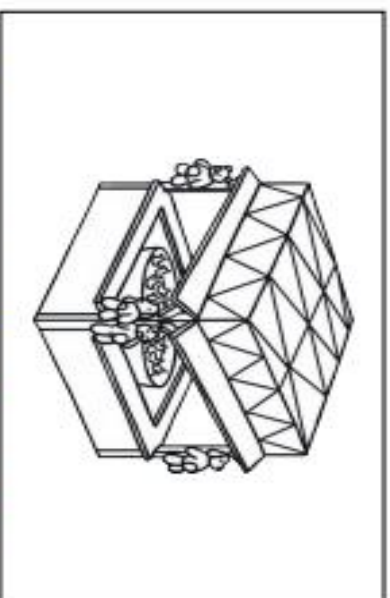

Clair and Gair had lots of fun. Clair went to the hook-a-duck. She got a duck and then a doll.



Gair had to finish at the fair, as his mum was waiting. He felt it was unfair, as Clair was still at the park. He might go back again the next day.

Colour in all the air words you can find



Tick the real words and cross the nonsense words



Key

Real Words



Nonsense Words



air	chair	thair	trair
mairs	fair	zair	lair
thairn	kairsh	hair	shairm
vairs	pair	jair	nairs
flair	stairs	sair	repair

★ Spelling words with air ★

Write the words in the spaces. There is a line for each letter of the word.

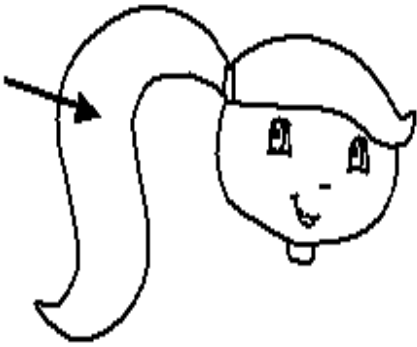



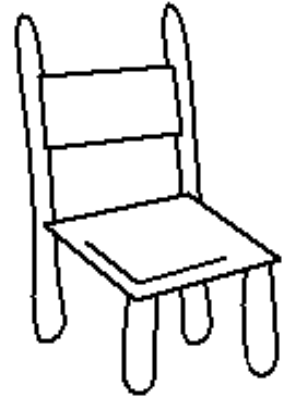

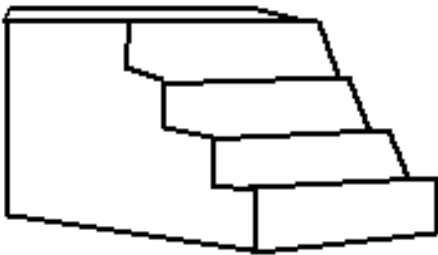

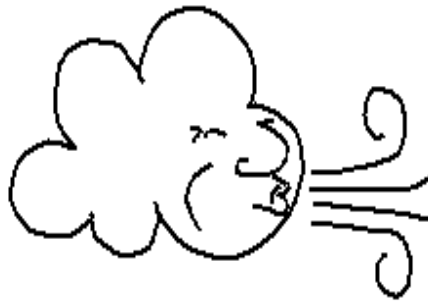



_____ y

Answers- 1. hair 2. pair 3. chair 4. stairs 5. air 6. fairy

Take the time to introduce this sound to your child. Tell them the sound and encourage them to colour in the sound as they read the words.

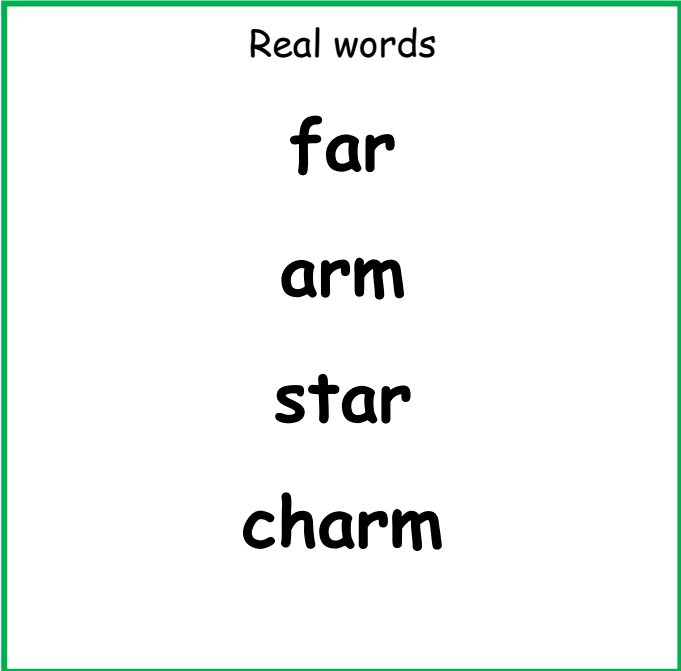
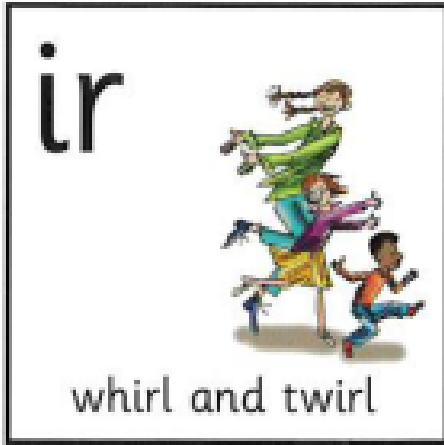

Alien words





Colour in all the ir words you can find



Dear Merlin,

I want to tell you all about my dance class! I think you would love it. All the girls and boys line up and when the music starts to play, we twirl and whirl! You should see the way my skirt swirls around as I dance!

Yesterday, a bird flew into the hall as we were learning our dance! The bird flapped and chirped, and made the hall very dirty. The bird even made the teacher's shirt dirty! "Look at your shirt, sir!" said one of the girls. It was very funny.

I hope you will come and see our swirly dance when it is finished!

Lots of love,

Shirley x





Tick the real words and cross the nonsense words



Key

Real Words



Nonsense Words



chirt	skirt	lirt	thirteen
dirt	tirl	sir	mirst
pirst	thirsty	zirst	stir
shirt	rirst	first	birteen
firl	bird	mird	girl

★ Spelling words with ir ★

Write the words in the spaces. There is a line for each letter of the word.





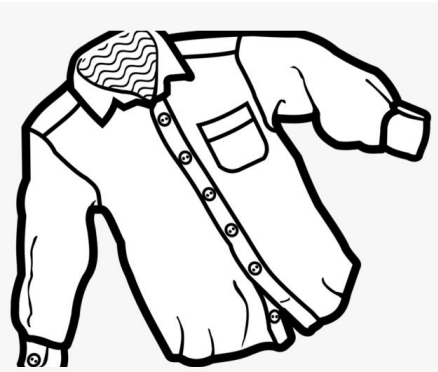

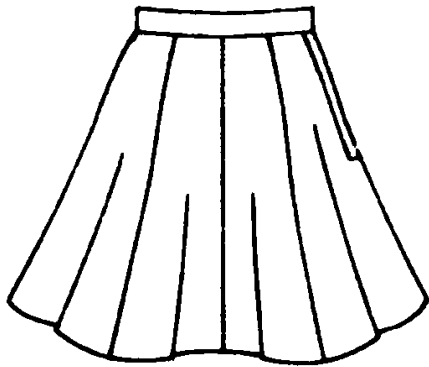





Answers- 1. bird 2. girl 3. shirt 4. skirt 5. first 6. third

Take the time to introduce this sound to your child. Tell them the sound and encourage them to colour in the sound as they read the words.

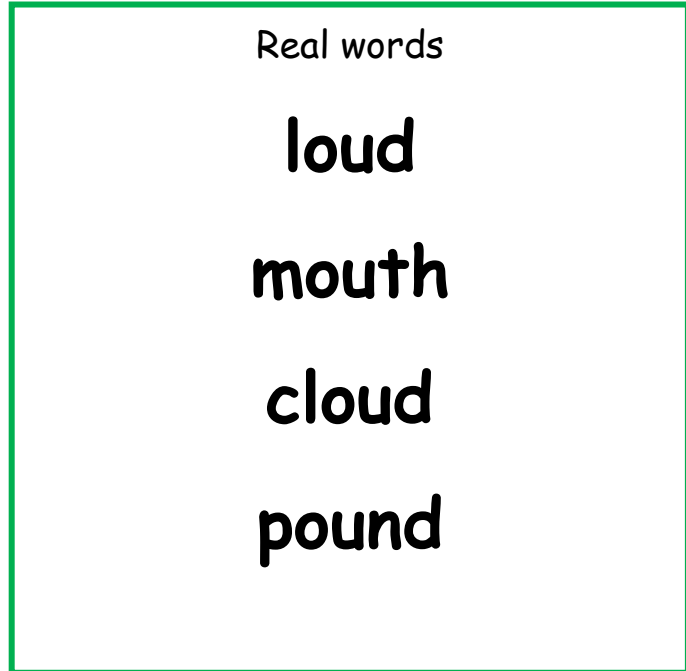

Alien words

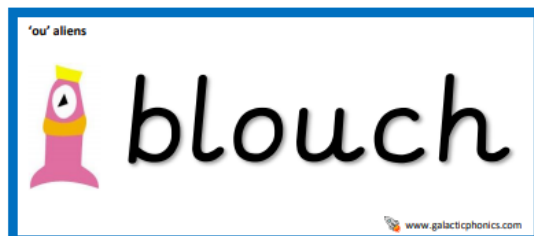



Colour in all the ou words you can find



What a Foul!

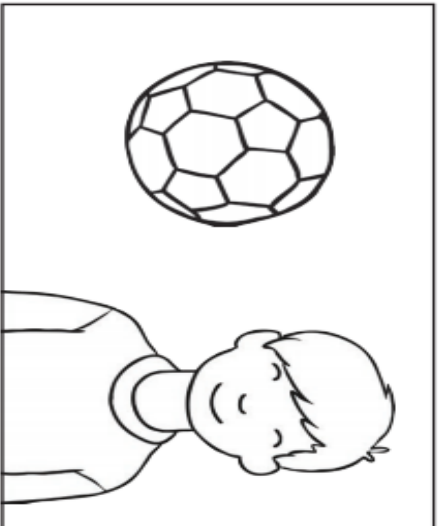

Kiran was delighted about his first county football match. They were a good team and were bound to win.

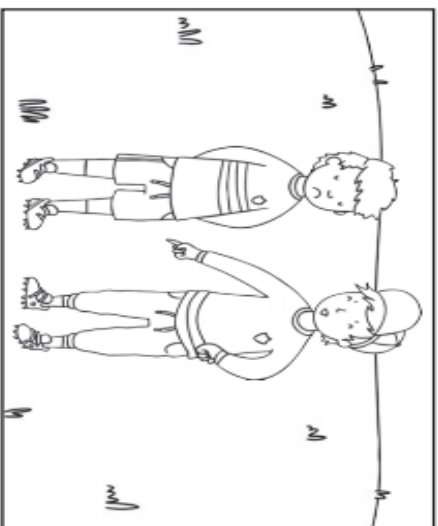

He got to the football ground and looked around. The boys from Wessex County were big and loud.

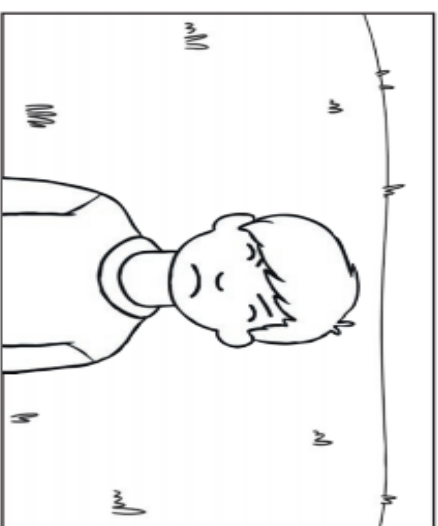

As soon as the game began, one of the Wessex boys gave him a hard clout.
'You lout!' shouted Kiran. 'That was a foul!' But the referee had not seen the clout.



Tick the real words and cross the nonsense words



Key

Real Words



Nonsense Words



gloud	hout	around	wout
found	cout	sound	foun
koun	pound	round	joud
out	count	loun	mouth

★ Spelling words with ou ★

Write the words in the spaces. There is a line for each letter of the word.







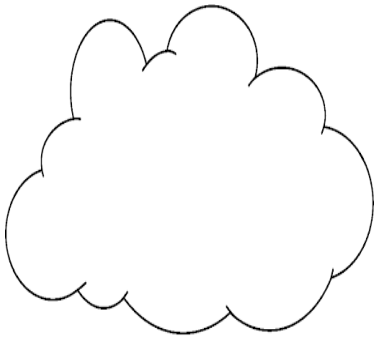



----- e



----- e

Answers- 1.loud 2.pound 3. mouth 4. cloud 5. mouse 6. house

Take the time to introduce this sound to your child. Tell them the sound and encourage them to colour in the sound as they read the words.

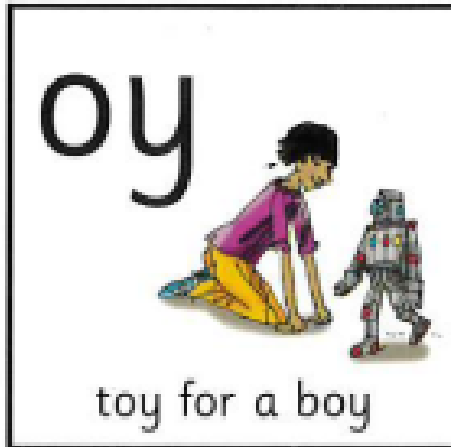

Real words

joy

ahoy

loyal

annoy

Alien words





Colour in all the oy words you can find



Dear Conroy,

I am full of joy! I have just been employed on Blackbeard's ship. No, not a toy ship... a real ship!

I am now a loyal sailor of the seven seas. I will eat oysters and shout "land ahoy!" from the top of the mast. I will not annoy Blackbeard or he will throw me off the boat!

I will enjoy my job on the boat but I think that I will miss you lots. It will be a joy to see you as I visit land.

Best wishes,

Joy Savoy x



Tick the real words and cross the nonsense words



Key

Real Words



Nonsense Words



enjoy	gloy	loyal	denoy
floy	toy	enpoy	annoy
ahoy	zoy	royal	noy
aoy	oyster	proyp	destroy
boy	moyn	voyage	scoyl

★ Spelling words with oy ★

Write the words in the spaces. There is a line for each letter of the word.

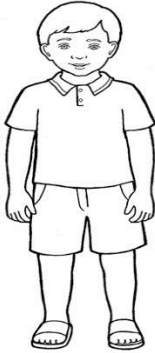





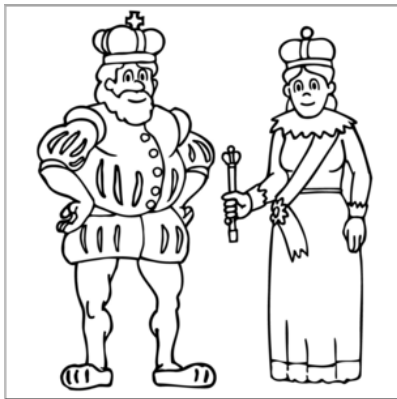



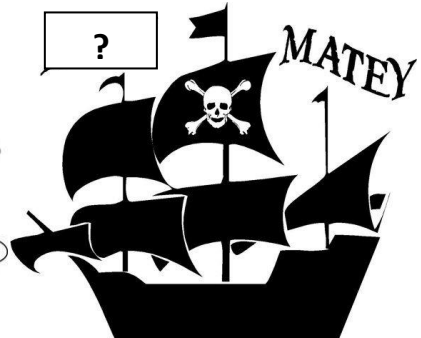

Answers-1.boy 2.toys 3.enjoy 4.royal 5.annoy 6.ahoy